



DATASHEET

VGP30

v1.1

1. Datasheet

1.1. VGP30

General Properties	Minimum	Typical	Maximum	Unit
Vacuum	5 % -0.05 1.5	- - -	60 % -0.607 17.95	[Vacuum] [Bar] [inHg]
Air flow in total	0	-	440	[L/min]
Air flow on each channel	0	-	220	[L/min]
Payload on cardboard boxes	- -	- -	30 66.13	[kg] [lb]
Vacuum cups	1	20	20	[pcs.]
Gripping time (measured with vacuum target 30%)	-	150	-	[ms]
Releasing time	-	80	-	[ms]
Noise level	-	59	62	[dB(A)]
Vacuum pump	Compressed air input			
Dust filters	Integrated 50µm, field replaceable			
IP Classification	IP54			
Dimensions	390 x 240 x 62.10 15.35 x 9.45 x 2.44			[mm] [inch]
Weight	3.1 6.83			[kg] [lb]

Operating Conditions	Minimum	Typical	Maximum	Unit
Power supply	20	24	25	[V]
Current consumption	50	750	2000	[mA]
Operating temperature	0 32	- -	50 122	[°C] [°F]
Relative humidity (non-condensing)	0	-	95	[%]
Calculated operation life	30 000	-	-	[hours]
Compressed air flow	-	-	440	[L/min]
Compressed air pressure	-	-	7	[bar]

2 Channels

The VGP30 has 2 channels, A and B, that can be operated together or independently. It is equipped with a total of 20 holes, each fitted with a vacuum cup. If needed, you can replace vacuum cups with the 12 provided blinding screws.

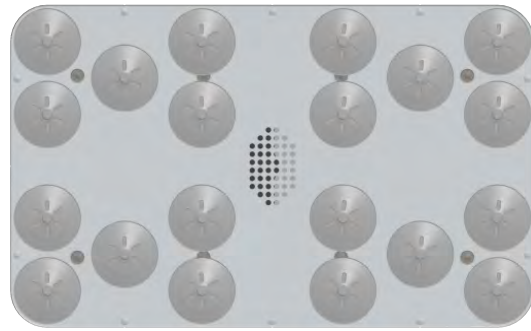

Compressed air guidance

The gripper operates with compressed air between 3 and 7 bar.

- For 60% vacuum (maximum): An input pressure of around 6.3 bar and an airtight workpiece (without leakage) is needed.
- For 30% vacuum (common to handle cardboard boxes): An input pressure of around 5 bar is needed.

Be aware that the dynamic compressed air pressure (when air is actively flowing) reaching the gripper is a bit lower than the static pressure measured at the compressor. This is due to potential pressure loss in the tubes, fittings and other components connecting the compressor to the gripper.

How to connect the external air compressor

To connect the compressed air:

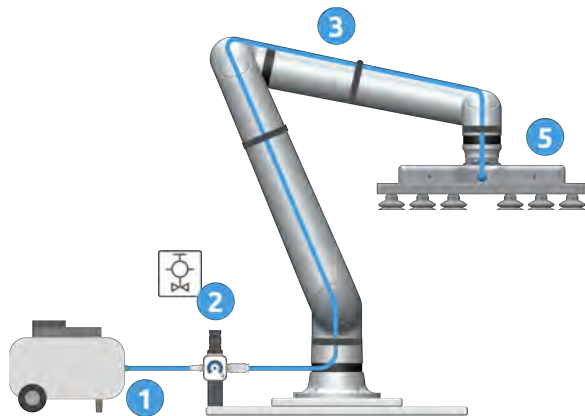

1. Attach the hose to the air compressor.
2. Connect the compressor to a filter regulator that complies with ISO 8573-1:2010 class 4. We offer a filter regulator kit PN 114743 that can be ordered separately.
3. Guide the hose along the robot without connecting it to the gripper.
4. Flush the hose to eliminate residual particles.
5. Attach a Ø10 hose in the plug-in union for compressed air hoses on the VGP30.



NOTE:

Ensure that the compressed air is filtered according to ISO 8573-1:2010 class 4, maintains a constant gripper input pressure up to 7 bar depending on required vacuum level, and the maximum recommended length of the hose is 10 meters.

VGP30 Reinforcement Bracket



NOTE:

The reinforcement bracket must be used with robots rated for payloads of 20 kg and above.



The Reinforcement Bracket enhances the gripper's robustness. It also increases the torque capacity by an additional 120 Nm, complementing the total allowable torque with the QC torque. The bracket weight is 0.3 kg (0.66 lb).



Airflow

Airflow is the amount of air that must be pumped to maintain the target vacuum. A completely tight system will not have any airflow, whereas real life applications have some smaller air leakages from two different sources:

- Leaking vacuum cup lips
- Leaking workpieces

The smallest leak under a vacuum cup can be hard to find (see picture below).

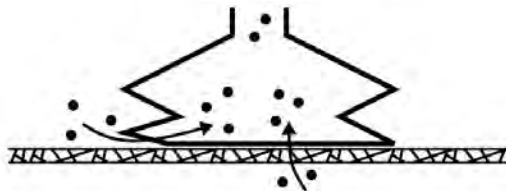

Leaking workpieces can be even harder to identify. Things that look completely tight might not be tight at all. A typical example is coarse cardboard boxes. The thin outer layer is often requiring a lot of airflow to create a pressure difference over it (see figure below).

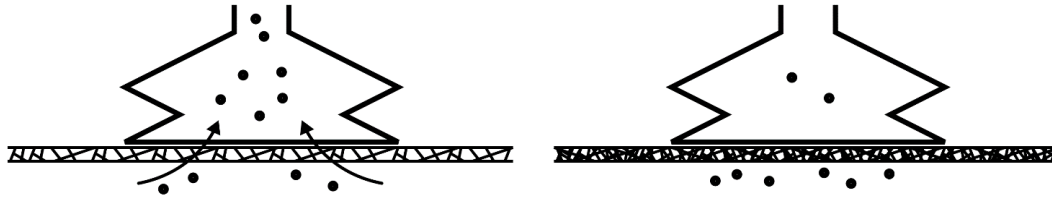

Be aware of the following:

- Pay extra attention to leakages, e.g. vacuum cup shape and surface roughness.
- When gripping an object with high leakage, be sure to use both channels if possible.

Fittings and blind screws

It is possible to change the suction cups simply by pulling them off the fittings. Stretch the silicon to one of the sides and then pull the suction cup out.

Unused holes can be blinded using a blind screw, and each fitting can be changed to a different type to match the desired suction cup. The fittings and the blinding screws are mounted or dismounted by screwing (2 Nm tightening torque) or unscrewing them with the provided 6 mm hex key.

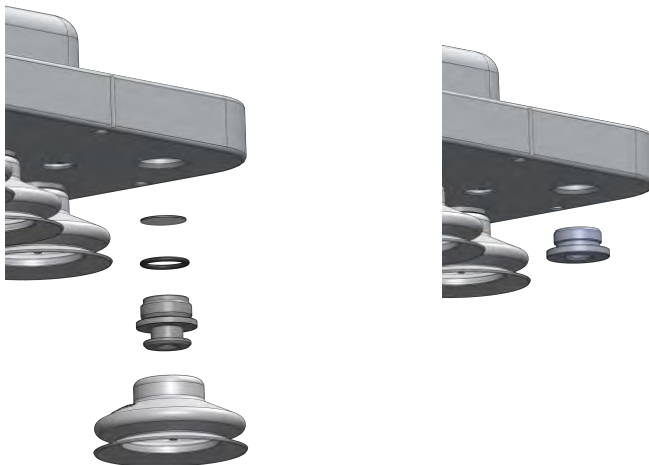

Fittings

Blind

The thread size is the commonly used G3/8"; allowing for standard fittings, blinders, and extenders to be fitted directly to the gripper.

VGP30 Inlet Filter

The filter is designed to stop or prevent larger particles from accidentally entering the gripper during operation. Regular maintenance ensures optimal performance and longevity of the gripper. The filter can be replaced (Filter Kit PN 114733) or cleaned; however, under normal use and following the specified use of clean filtered air outlined above, the filter does not require replacement or cleaning.



To remove the **(A) Inlet Filter**, use a 7 mm hex key to unscrew and remove the **(B) fitting**, then carefully remove the **(C) o-ring** with a small screwdriver. Place the gripper on its side with the filter hole facing downward, allowing the filter to slide out naturally by gravity.

1.2. VGP30 box content

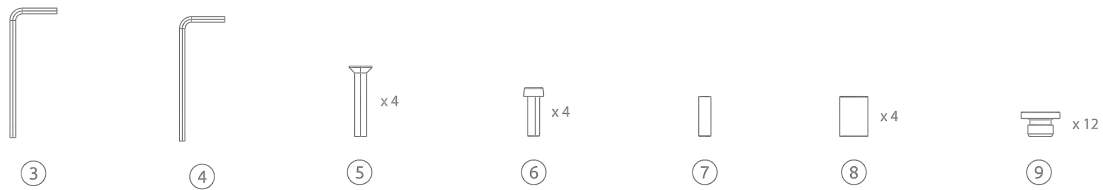
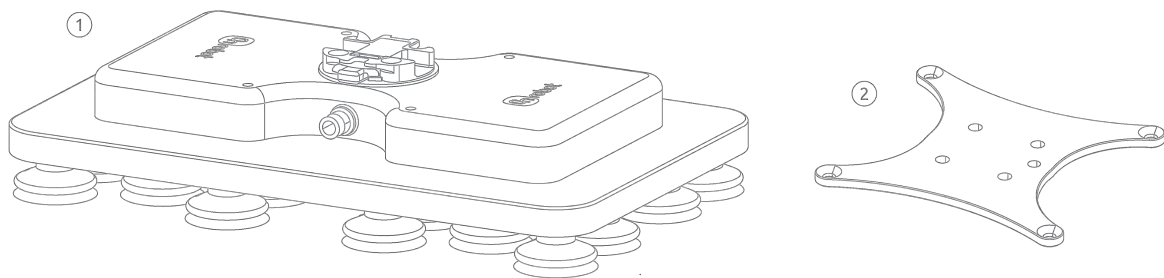

- | | | |
|-------------------------|---------------------------|-------------------------|
| ① VGP30 | ④ Allen key 6 mm | ⑦ Pin Ø6h&25mm ISO 2338 |
| ② Reinforcement Bracket | ⑤ Screws M6x40mm ISO14581 | ⑧ Bushings |
| ③ Allen key 8mm | ⑥ Screw M6x25mm ISO14580 | ⑨ Blinds 3/8 size |

1.3. VGP30

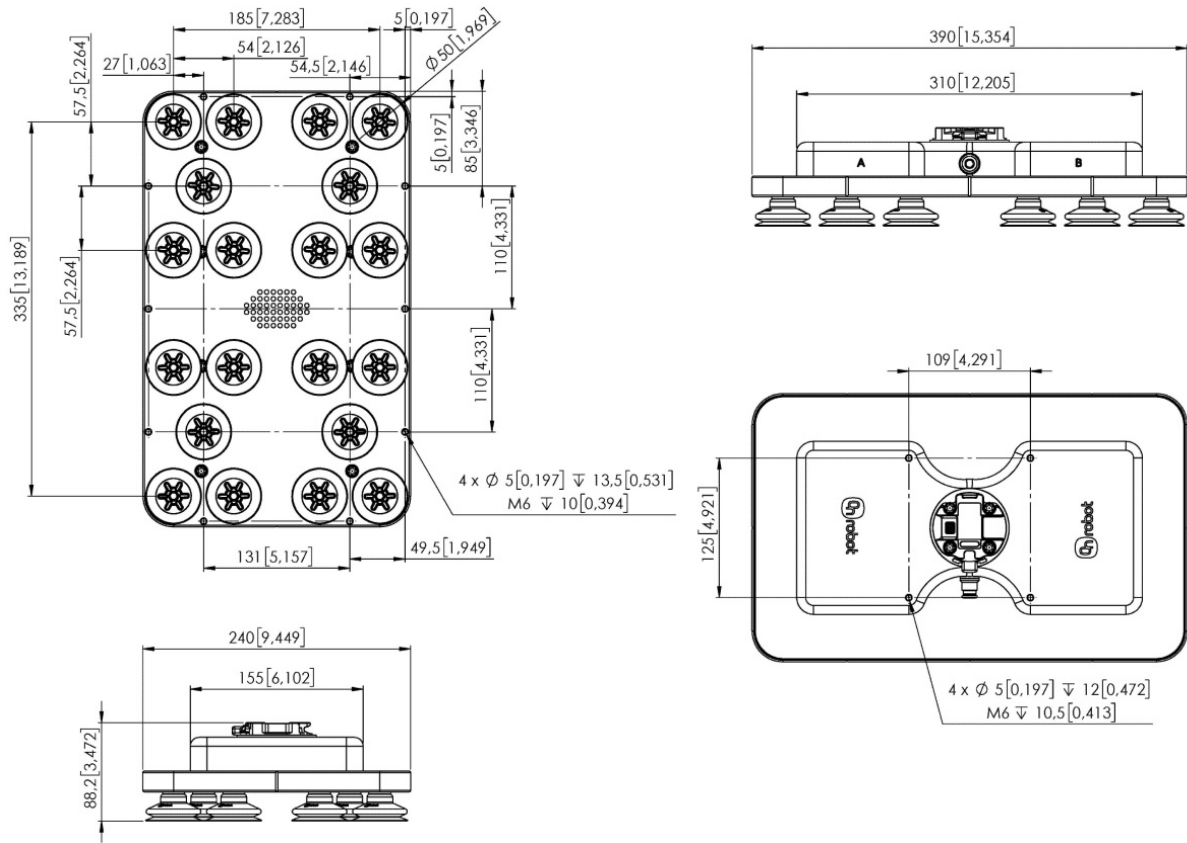

VGP30 with the Reinforcement Bracket

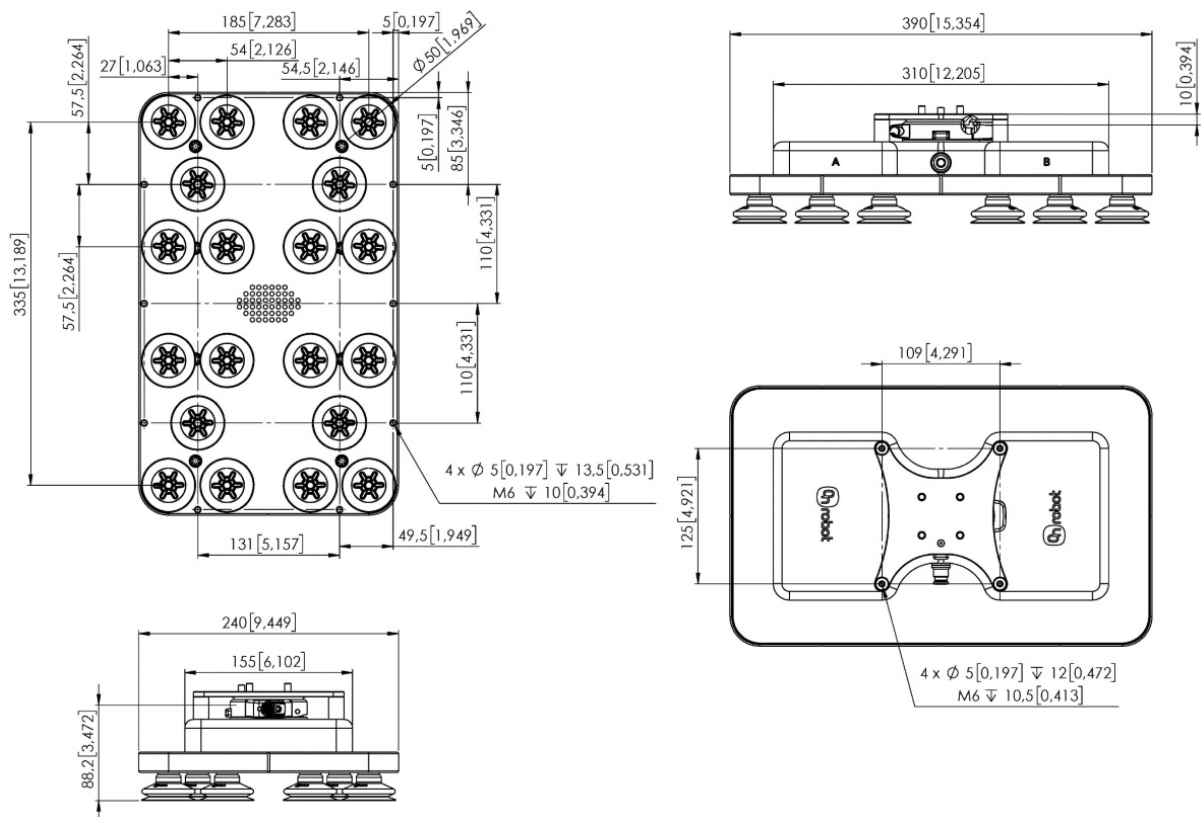

All dimensions are in mm and [inches].